

1506A-E88TAG1

1500

Series

196 kWm standby @ 1500 rpm
239 kWm standby @ 1800 rpm

Basic technical data

Number of cylinders	6
Cylinder arrangement	Inline
Cycle	4 stroke
Induction system	Air to air aftercooled, turbocharged
Compression ratio	16.1:1
Bore	112 mm (4.41 inches)
Stroke	149 mm (5.87 inches)
Displacement	8.8 litres (537.0 inches ³)
Direction of rotation	Anticlockwise facing flywheel
Firing order (number 1 cylinder furthest from flywheel)	1, 5, 3, 6, 2, 4
Estimated total weight of ElectropaK (dry)	1156 kg
Estimated total weight of ElectropaK (wet)	1235 kg

Overall dimensions

Length, front of radiator to rear of air cleaner	1941 mm
Width	1013 mm
Height, including radiator support brackets	1366 mm

Moments of rotational inertia (mk²)

Engine	0.7361 Nms ²
Flywheel SAE14	1.667 Nms ²

Centre of gravity

Forward of rear face of cylinder block	413 mm
Above crankshaft centre line	231 mm
Offset RHS of centre line	-1 mm

Performance

All ratings certified to within	± 3%
Speed variation at constant load	± 0.25%

Note: Data based on ISO/TR14396, SAE J1995 3.1, ISO3046-1.

Note: Engine speed control in accordance with BS5514 pt.4; ISO3046-4 and ISO8528-5.

Note: Electrical ratings are based on average alternator efficiency and are for guidance only.

Test conditions

Air temperature	25°C
Barometric pressure	100 kPa
Relative humidity	35%
Air inlet restriction at maximum power (nominal)	3.7 kPa
Exhaust back pressure at maximum power (nominal)	10 kPa
Fuel temperature (inlet pump)	40°C

Note: If the engine is to operate in ambient conditions other than those of the test conditions, suitable adjustments must be made for these changes.

For full details, contact Perkins Technical Service Department.

General installation

1506A-E88TAG1

Designation	Units	Type of operation and application			
		Standby power	Prime power	Standby power	Prime power
		50 Hz @ 1500 rpm		60 Hz @ 1800 rpm	
Gross engine power	kWb	210	192	255	233
Fan power	kWm	8	8	13	13
Restrictions and other losses	kWm	4.2	3.9	4.8	4.5
ElectropaK nett engine power	kWm	198	180	237	216
Gross BMEP	kPa	1909	1745	1932	1765
Combustion air flow	m ³ /min	13.5	12.8	18.6	17.7
	kg/hr	953	908	1314	1253
Exhaust gas temperature after turbocharged (maximum)	°C	470	458	444	431
Exhaust gas flow, wet	m ³ /min	31.9	30.2	42.1	39.7
	kg/hr	993	946	1365	1300
Boost pressure ratio		2.7	2.5	3.2	3.1
Overall thermal efficiency (nett)	%	43	43	43	43
Mean piston speed	m/s	7.4	7.4	8.9	8.9
Engine coolant flow	l/min	140	140	190	190
Cooling fan air flow	m ³ /min	370	370	482	482
Typical generator set electrical output (0.8pf)	kWe	182	166	218	198
	kVA	228	207	273	248
Assumed alternator efficiency	%	92	92	92	92

Energy balance

Designation	Unit	Standby power	Prime power	Standby power	Prime power
		50 Hz @ 1500 rpm		60 Hz @ 1800 rpm	
		Energy in fuel	kWt	476	446
Energy in power output nett (at shaft)	kWb	198	180	237	216
Energy to restrictions/other losses	kWb	4.2	3.9	4.8	4.5
Energy to coolant	kWt	93	89	107	101
Energy to exhaust	kWt	139	135	180	165
Energy to ACC	kWt	28	25	52	42
Energy to cooling fan	kWm	8	8	13	13
Energy to radiation	kWt	6	5	6	6

Note: The above data is based on 42,770 KJ/Kg calorific value for diesel conforming to specification BS2869 Class A2.

Rating definitions

Prime power

Variable load. Unlimited hours usage with an average load of 70% of the published prime power rating. A 10% overload is available for 1 hour in every 12 hours of operation.

Standby power

Variable load. Limited to 500 hours annual usage up to 300 hours of which may be continuous running. No overload is permitted.

Cooling system

Total coolant capacity	29.6 litres
Engine	13.9 litres
Radiator	12.6 litres
Pipes and hoses	3.08 litres
Maximum top tank temperature	107°C
Maximum static pressure head on pump	N/A kPa
Thermostat operating range	87 - 98°C
Coolant flow, against 30 kPa restriction @ 1500 rpm	140 litres/min
Coolant flow, against 30 kPa restriction @ 1800 rpm	190 litres/min
Maximum temperature rise across the engine	N/A°C

Radiator

Radiator face area	0.49 m ²
Number of rows and material	4/Aluminium
Fins per inch and material	10 FPI
Pressure cap setting (minimum)	110 kPa

Charge cooler

Face area	0.26 m ²
Number of rows and material	2/Aluminium
Fins per inch and material	10 FPI

Width and height of matrix

Height	1172 mm
Width	900 mm
Weight of cooling pack (dry)	84 kg

Coolant pump

Method of drive	Belt driven
-----------------	-------------

Fan type/details

Diameter	813 mm (32 inches)
Drive ratio	1:1
Material	Plastic
Number of blades	9
Pusher/puller	Pusher
Cooling fan air flow @ 1500 rpm	370 m ³ /min
Cooling fan air flow @ 1800 rpm	482 m ³ /min

Duct allowance

Ambient cooling clearance (standby power) based on air temperature at fan of 7°C above the ambient.

Maximum additional restriction (duct allowance) to cooling airflow and resultant minimum airflow.

Description	@ 1500 rpm	@ 1800 rpm
Ambient clearance	51°C	54°C
Duct allowance	125 Pa	
Minimum airflow at conditions	370 m ³ /min	482 m ³ /min

Normal operating angles:

Front and rear	± 7°
Side tilt	± 7°

Fuel system

Recommended fuel to conform to BS 2869 1998 CLASS A2 or BSEN590.

Injection system	Direct
Injector type	Hydraulically Actuated Electronically Controlled Unit Injector
Governor type	Electronic
Injector pressure	185 MPa
Lift pump type	Gear
Lift pump fuel delivery @ 1500 rpm	132 litres/hour
Lift pump delivery pressure	140-655 kPa
Maximum suction head at pump inlet	60.9 kPa
Maximum static pressure head	4 m
Maximum fuel inlet temperature	79°C
Fuel filter spacing	4 Microns
Tolerance on fuel consumption	± 5%

Fuel consumption

Note: All figures based on gross engine power and assumed fuel density of 0.85 kg/litre.

1506A-E88TAG1

Rating	1500 rpm		1800 rpm	
	g/kWh	litres/hr	g/kWh	litres/hr
Standby	195.1	47.2	200.3	59.5
Prime	197.3	44.6	199.0	54.2
75% prime	199.8	33.9	202.7	41.6
50% prime	212.0	24.0	214.0	29.3

Induction system

Maximum air intake restriction of engine:

Clean filter	3.7 kPa
Dirty filter	6.2 kPa
Induction indicator setting	7.5 kPa
Air filter type	Dry paper element

Lubrication system

Total lubrication system capacity (dry engine)	41 litres
Total lubrication system capacity (oil change)	39 litres
Sump capacity only	36 litres
Oil temperature (in sump) maximum	120°C
Oil temperature (in sump) normal continuous operation	115°C
Lubricating oil pressure at bearings	370 kPa
Minimum oil pressure	250 kPa
Oil relief opens at	662 kPa
Oil filter screen spacing	23 Microns
Lubricating oil flow	200 litres/min
Oil consumption (highest rating)	<0.1% of fuel

Electrical system

Type (grounding)	Negative ground
Alternator type	20SI 24 volts
Alternator voltage	24 volts
Alternator output	45 amps
Starter type	Electric
Starter motor voltage	24 volts
Starter motor power	5.3 kW or 6 kW
Number of teeth on flywheel	113
Number of teeth on starter pinion	11
Minimum mean cranking speed	100 rpm
Starter solenoid maximum pull-in current @ 20°C	215 amps
Starter solenoid maximum hold-in current @ 20°C	.6 amps

Load acceptance (cold)

1506A-E88TAG1

Rating	Prime %	kWe	Transient frequency deviation, %	Frequency recovery time, seconds
50 Hz/1500 rpm	74	119	9.5	3.0
60 Hz/1800 rpm	82	160	8.7	2.5

Note: The information shown above complies with the requirements of ISO 8528-5 stated G2 operating limits.

The figure shown in the table above were obtained under the following test conditions:

Minimum engine block temperature	45°C
Alternator efficiency @ 1500 rpm	93.8%
Alternator efficiency @ 1800 rpm	94.1%
Ambient temperature	25°C
Governing mode	Isochronous
Typical alternator inertia	3.3759 kgm ²
Under frequency roll off (UFRO) set to @ 1500 rpm	49.5 Hz
Under frequency roll off (UFRO) set to @ 1800 rpm	59.5 Hz
Alternator manufacturer	Leroy Somer
Alternator model	LSA46.2VL12

Note: All tests were conducted using an engine installed and serviced to Perkins Engines Company Limited recommendations.

The information given on this technical data sheet is for guidance only. For ratings other than shown, installation guidance, please contact Perkins Engines Company Limited, United Kingdom.

Cold start recommendations at -20°C

Oil SAE	0W-30
Starter type	1 x 24 volts
Battery	24 volts
Maximum breakaway current	998 amps
Cranking current	243 amps

Starting aids

Block temperature	45°C
-------------------	------

Exhaust system

Maximum back pressure for total system	10 kPa
--	--------

Engine mountings

Maximum static bending moment at rear face of block	3134 Nm
Maximum permissible overhung load on flywheel	464 kg (at a distance of 65 mm)

Noise data

Noise levels

The figures for total noise levels are typical for an engine running at the standby continuous baseload power rating in a semi-reverberant environment and measured at a distance of one meter from the periphery of the engine (sound pressure level re: -20×10^{-6} Pa. Ambient noise level load with open set at 264 kWe, standby @ 1500 rpm. All value measured at Sound Pressure Levels (SPL).

Position	Noise, dB(A)
1	96.7
2	98.1
3	93.8
4	97.7
5	102.2

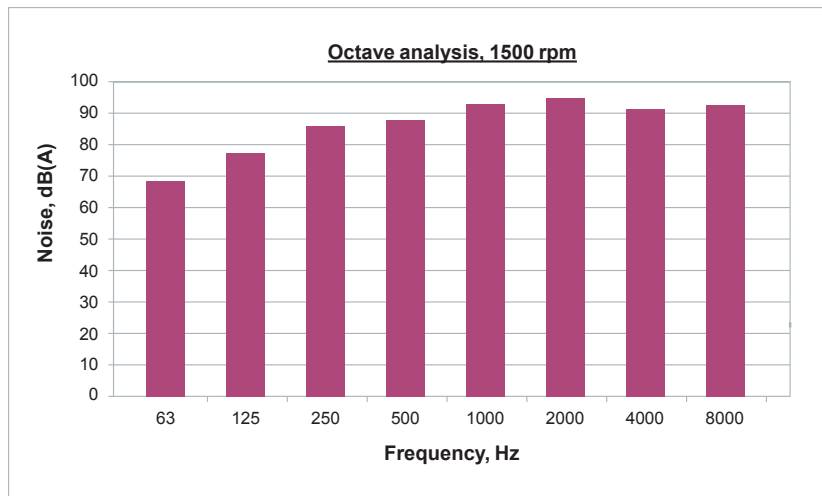
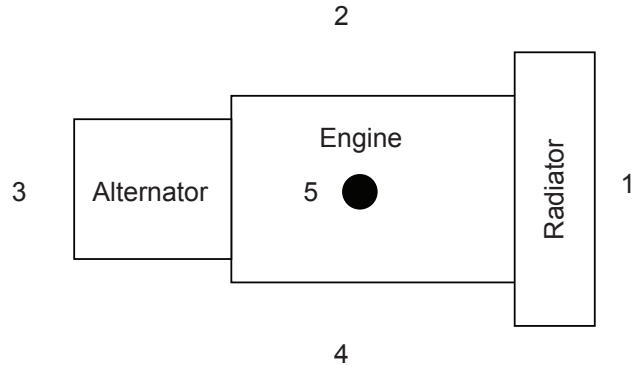

Frequency, Hz	Noise, dB(A)
63	69.2
125	77.7
250	86.4
500	87.0
1K	92.2
2K	93.3
4K	90.5
8K	91.0

1506A-E88TAG1 - Front view

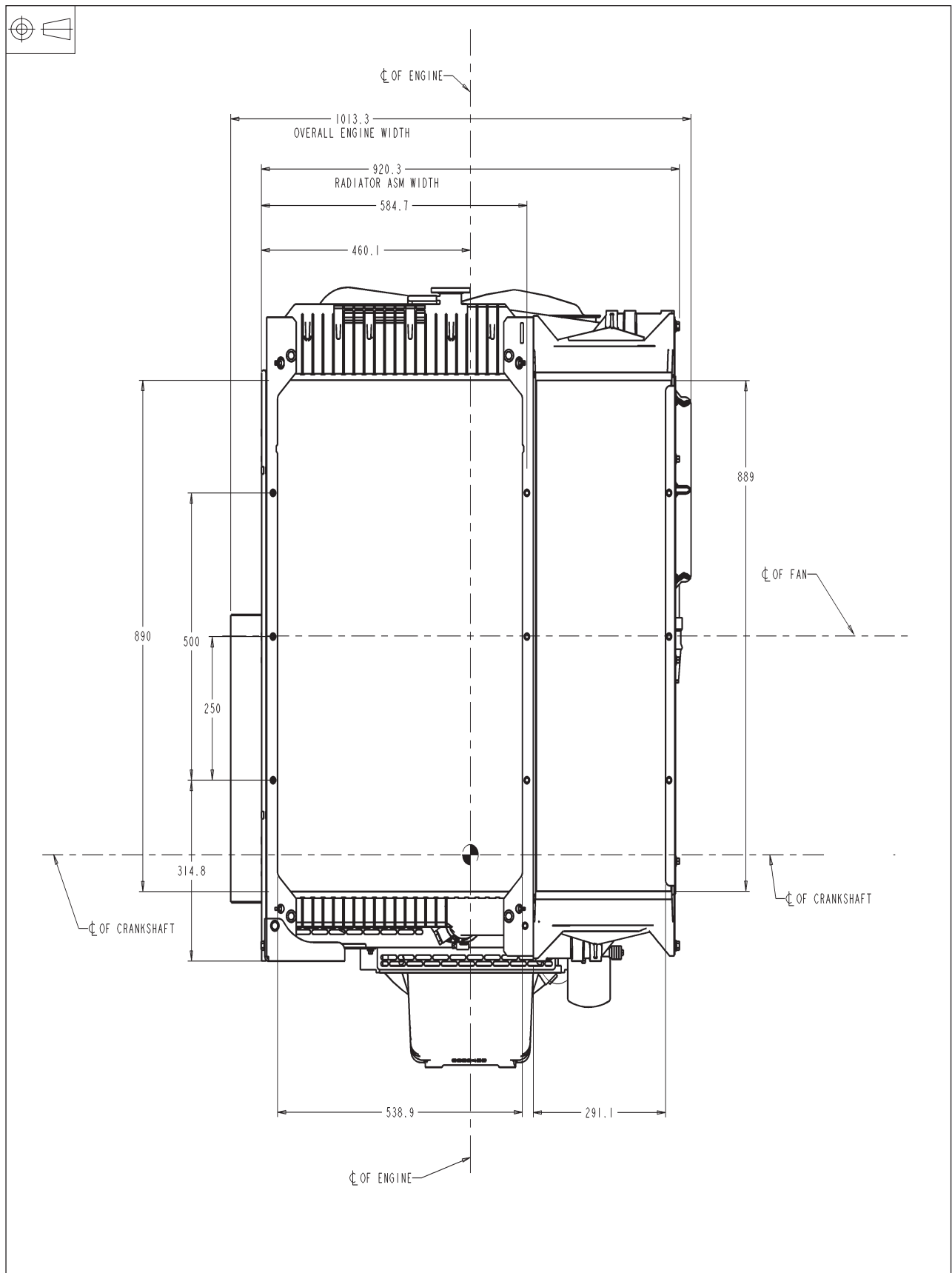

1506A-E88TAG1 - Right side view

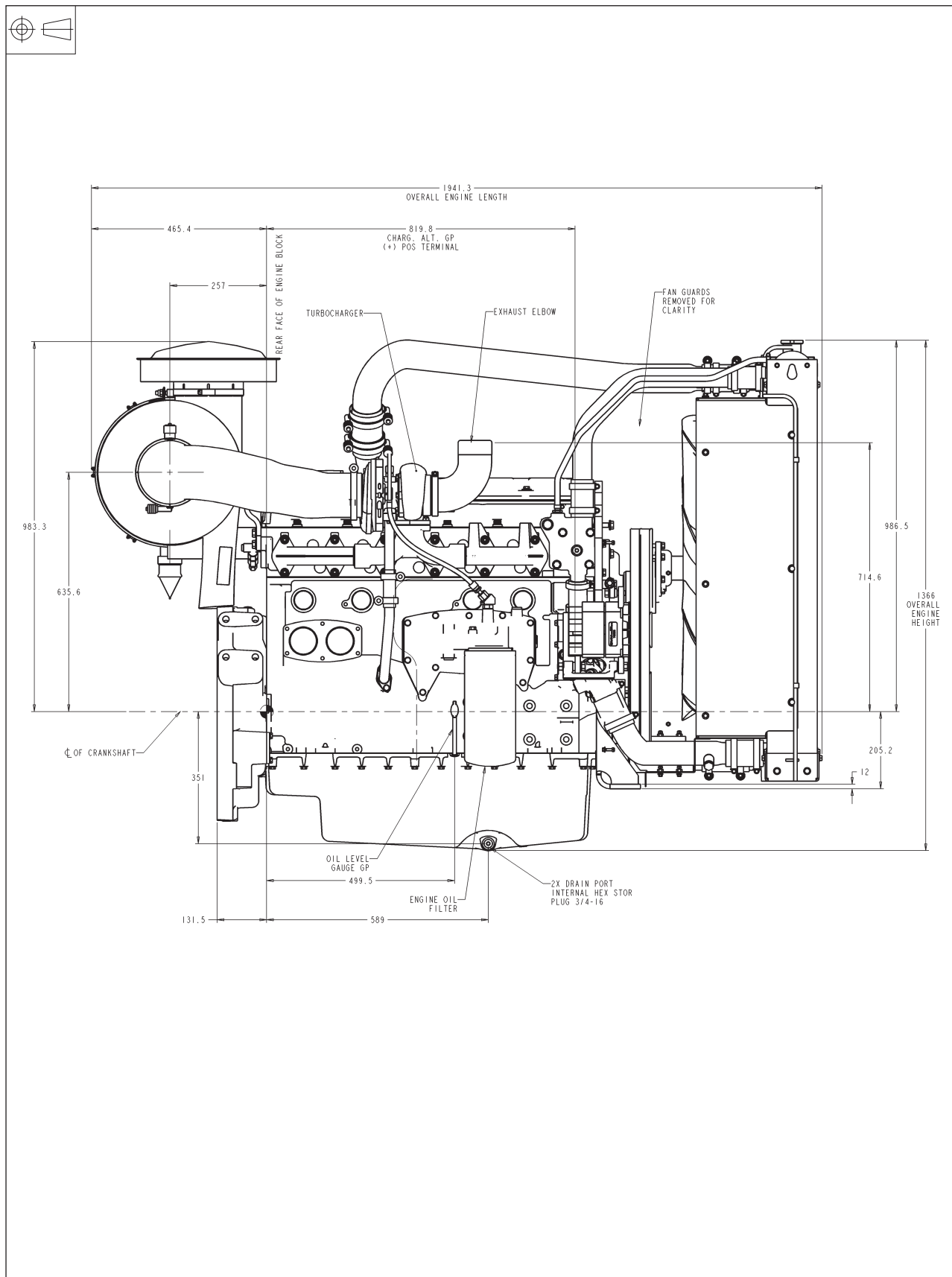

1506A-E88TAG1 - Rear view

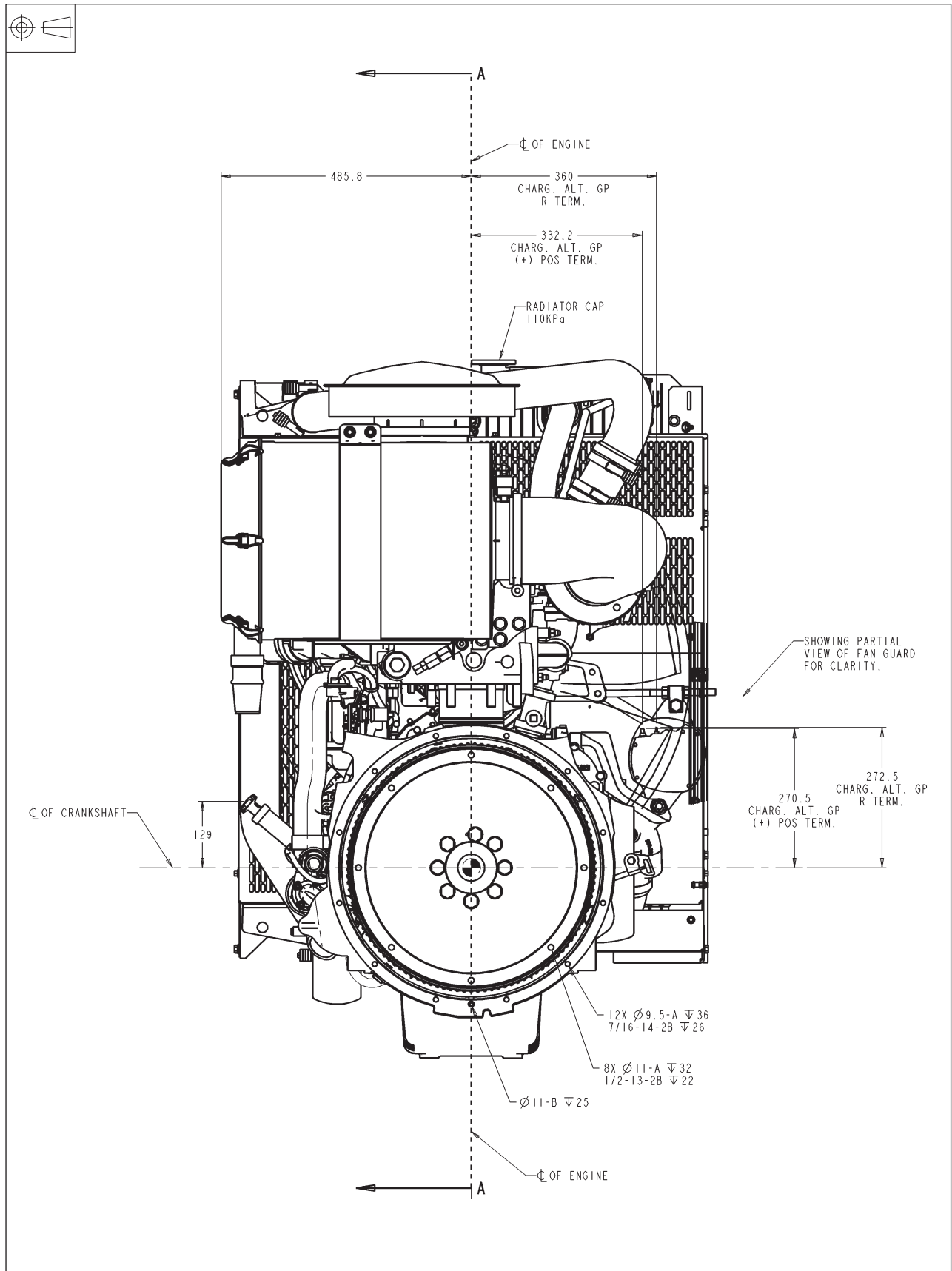

1506A-E88TAG1 - Left side view

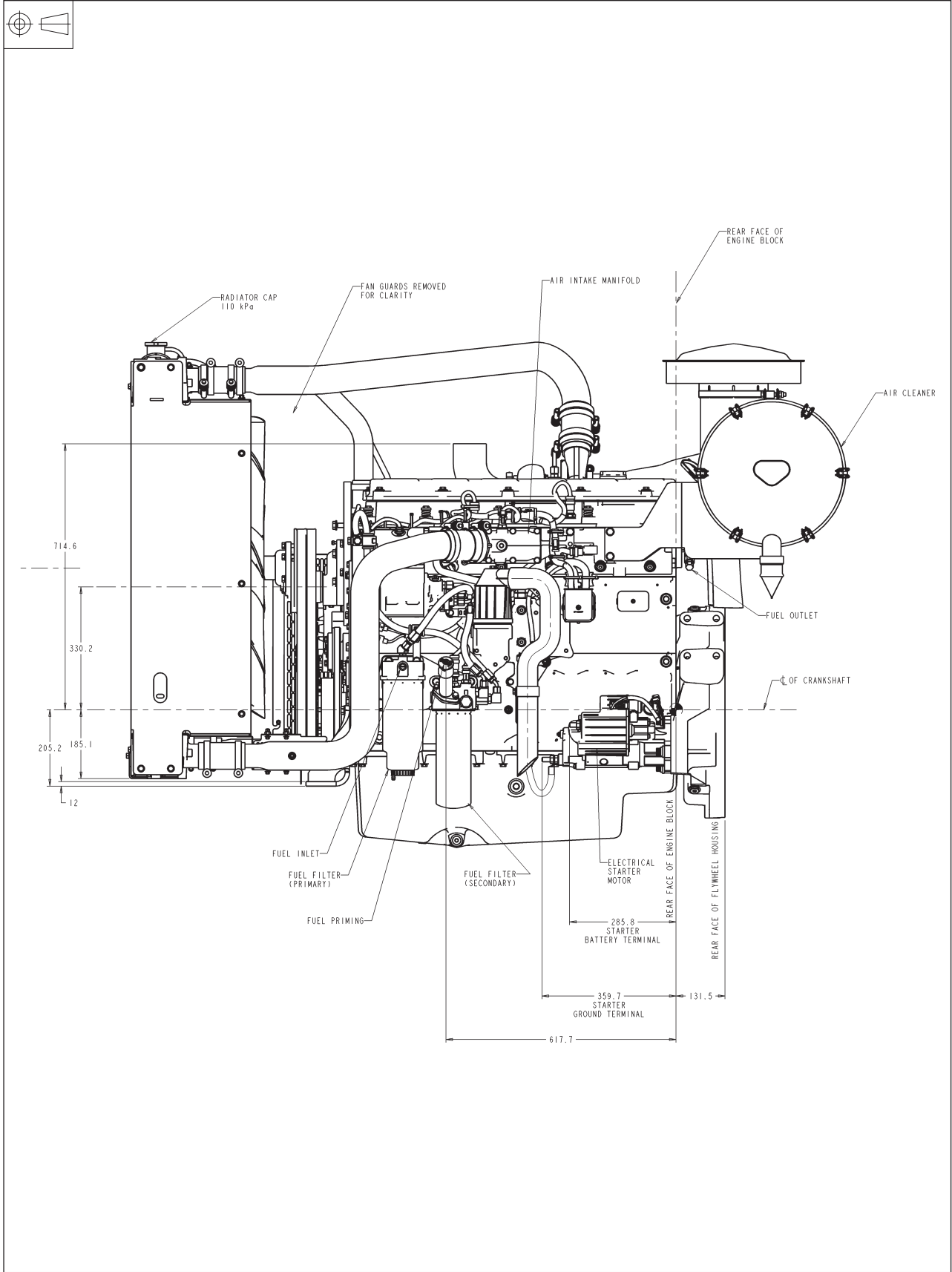

1506A-E88TAG1 - Plan view

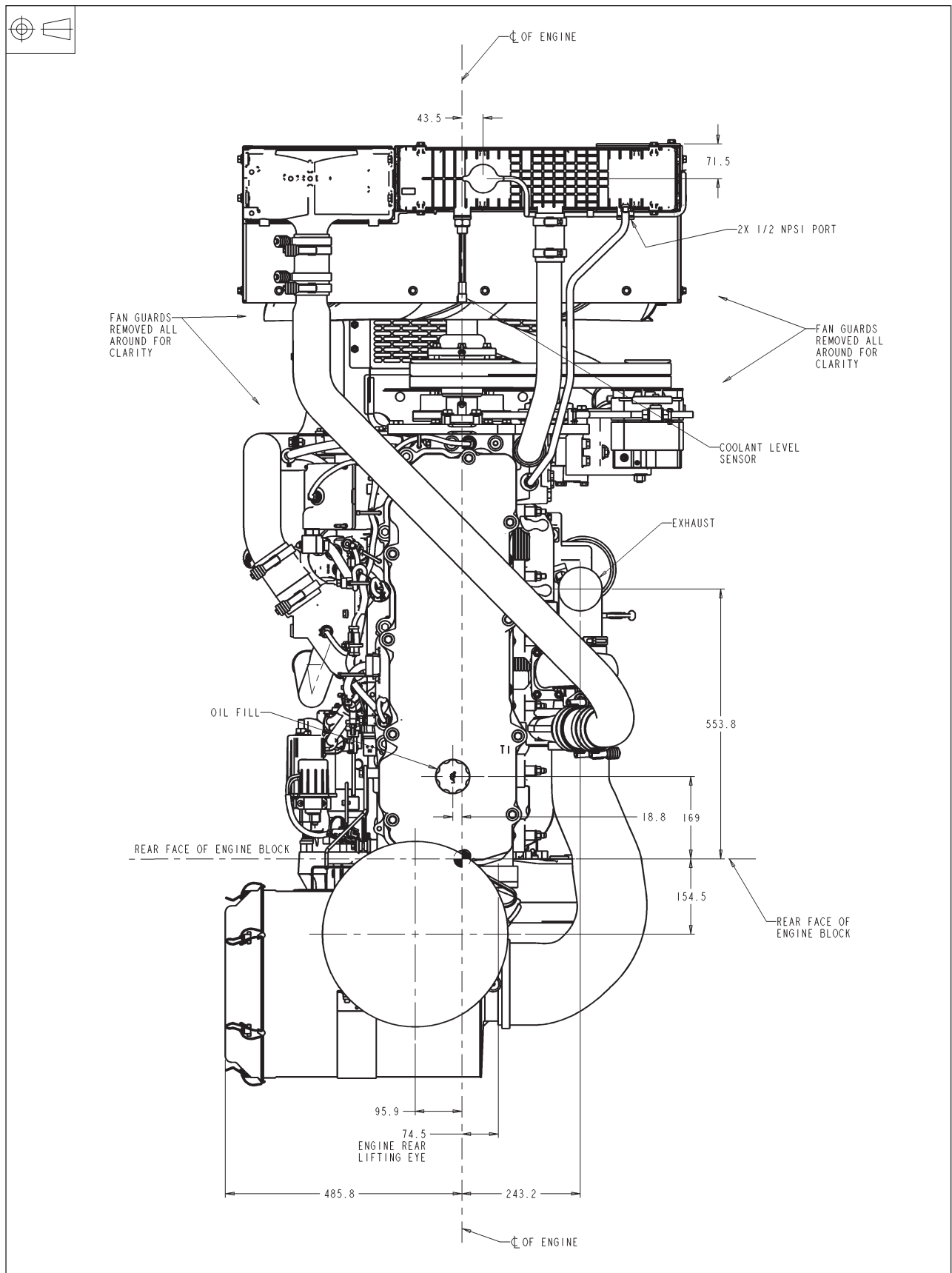

1506A-E88TAG1 - Under view

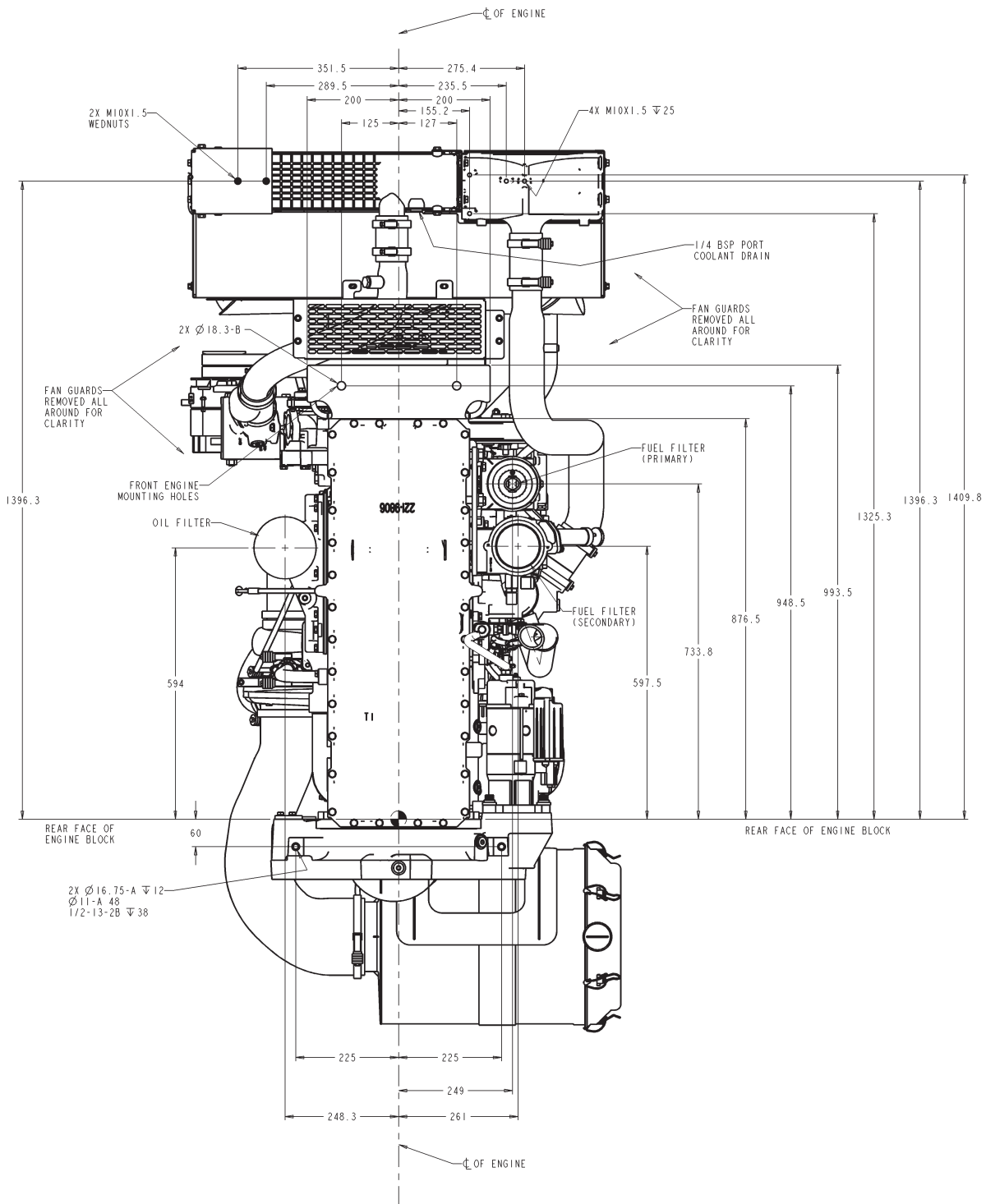

1506A-E88TAG1 - Connection details

