

2206D-E13TAG2

2206D-E13TAG3

ElectropaK

2200

Series

Basic technical data

Number of cylinders	6
Cylinder arrangement	Vertical inline
Cycle	4 stroke
Induction system	Turbocharged, air-to-air charge cooling
Combustion system	Direct injection diesel
Compression ratio	16.3:1
Bore	130 mm
Stroke	157 mm
Cubic capacity	12.5 litres
Direction of rotation	Anti clockwise when viewed from flywheel
Firing order (number 1 cylinder furthest from flywheel)	1, 5, 3, 6, 2, 4
Estimated total weight (dry)	1478 kg
Estimated total weight (wet)	1582 kg

Overall dimensions, ElectropaK

Height	1725 mm
Length (air cleaner fitted)	2410 mm
Width	1120 mm

Moments of inertia

Engine	1.36 kgm ²
Flywheel	1.41 kgm ²

Centre of gravity, ElectropaK

Forward from rear of block (wet)	650 mm
Above crankshaft centre line (wet)	250 mm

Cyclic irregularity

1800 rpm	1,82
----------	------

Performance

Steady state speed capability at constant load - G2... + 0,25%
All ratings certified to within... ±3%

Note: All data based on operation to ISO 3046-1/1, BS5514 and DIN 627 standard reference conditions.

Note: All data based on 42584 MJ/kg calorific value for diesel conforming to specification BS2869 Class A2.

Sound level

Sound pressure level (exhaust piped away, cooling pack and air cleaner fitted)

1800 rpm	104.6 dB(A)
----------	-------------

Test conditions

Air temperature	25°C
Barometric pressure	100 kPa
Relative humidity	30%
Air inlet restriction at maximum power (nominal)	2,5 kPa
Exhaust back pressure at maximum power (nominal)	6,8 kPa
Fuel temperature (inlet pump)	40°C

Note: If the engine is to operate in ambient conditions other than those of the test conditions, suitable adjustments must be made for these changes. For full details, contact Perkins Technical Service Department.

Emissions capability

Emits equivalent to U.S. EPA Tier 3 Nonroad Certified to U.S. EPA Emergency Stationary Standards

Emissions labelling options

- U.S. EPA Part 60 as an Emergency Stationary Engine.
- U.S. EPA Part 1039 Flex.

General installation

Designation	Units	2206D-E13TAG2		2206D-E13TAG3	
		60 Hz @ 1800 rpm			
		Prime	Standby	Prime	Standby
Gross engine power	kWb	373.4	406.5	406.5	461.7
Brake mean effective pressure (BMEP)	kPa	1984	2171	2171	2430
Combustion air flow (at rated speed)	m ³ /min	25.1	26.6	26.9	29.8
Exhaust gas flow (maximum)	m ³ /min	71.5	76.6	75.2	86.2
Exhaust gas mass flow	kg/min	29.5	31.3	31.5	35.0
Exhaust gas temperature (turbocharger outlet)	°C	680			
Boost pressure ratio	:1	2.8	3.0	2.9	3.3
Overall thermal efficiency (nett)	%	38.7	39.0	39.6	39.3
Typical generator set electrical output (0.8 pf 25°C)	kWe	320	350	350	400
	kVA	400	438	438	500
Assumed alternator efficiency	%	92.0			

Rating definitions

Prime power

Variable load. Unlimited hours usage with an average load factor of 70% of the published prime power rating over each 24 hour period. A 10% overload is available for 1 hour in every 12 hours of operation.

Standby power

Variable load. Limited to 500 hours annual usage up to 300 hours of which may be continuous running. No overload is permitted.

Energy balance

Designation	Units	2206D-E13TAG2		2206D-E13TAG3	
		60 Hz @ 1800 rpm			
		Prime	Standby	Prime	Standby
Energy in fuel	kWt	899.5	974.2	962.0	1107.5
Energy in power output (gross)	kWb	373.4	406.5	406.5	461.7
Energy to additional losses	kWb	5.6	6.1	6.1	6.9
Energy to cooling fan	kWm	19.0			
Energy in power output (nett)	kWt	348.8	381.4	381.4	435.1
Energy to exhaust	kWt	294.1	317.9	308.7	369.6
Energy to coolant and lubricating oil	kWt	138.5	1477	145.1	155.8
Energy to charge cooler	kWt	52.0	59.4	60.3	76.6
Energy to radiation	kWt	41.5	42.8	41.4	44.4

Cooling system

Radiator

Face area	1.238 mm ²
Number of rows and materials	1 row, Aluminium
Matrix density and material	12 fins per inch, Aluminium
Width of matrix	1048 mm
Height of matrix	1100 mm
Weight of radiator (dry)	132 kg
Pressure cap setting (minimum)	70 kPa

Charge cooler

Face area	1.006 mm ²
Number of rows and materials	1 row, Aluminium
Matrix density and material	12 fins per inch, Aluminium
Width of matrix	915 mm
Height of matrix	1100 mm

Coolant pump

Speed @ 1800 rpm	2468 rpm
Drive method	Gear

Fan

Diameter	927 mm
Drive ratio	0.92:1
Number of blades	9
Material	Composite
Type	Pusher
Cooling fan air flow @ 1800 rpm	788 m ³ /min

Coolant

Total system capacity	51,4 litres
Maximum top tank temperature	104 °C
Temperature rise across engine	10 °C
Maximum pressure in engine cooling circuit	70 kPa
Maximum permissible external system resistance	30 kPa
Maximum static pressure head on pump	30 kPa
Coolant flow against 30 kPa restriction	
1800 rpm	6.7 litres/sec
Thermostat operation range	87 to 98 °C

Note: For details of recommended coolant specifications, refer to the Operation and Maintenance Manual for this engine model

Duct allowance

Maximum additional restriction (duct allowance) to cooling airflow and resultant minimum airflow		
Description	2206D-E13TAG2	2206D-E13TAG3
Engine speed rpm	1800	
Ambient clearance inhibited coolant °C	53	59
Duct allowance Pa	200	
m ³ /min	716	

Electrical system

Type	24 volts negative earth
Alternator	22 SI
Alternator voltage	24 volts
Alternator output	70 amps
Starter motor type	39 MT
Starter motor voltage	24 volts
Starter motor power	7.8 kW
Number of teeth on the flywheel	113
Number of teeth on starter pinion	11
Minimum cranking speed	106 rpm
Starter solenoid maximum	
Pull-in current @ 0 °C	200 amps
Hold-in current @ 0 °C	25 amps

Cold start recommendations

	5 to -10 °C	-11 to -25 °C
SAE grade oil	15W40	5W40
Starter	42MT	
Battery	24 volts	
Maximum breakaway current	1311 amps	1585 amps
Cranking current	588 amps	828 amps
Starting Aids (ECM controlled)	None	Block heater 1,5 (110V/240V)
Minimum mean cranking speed	106 rpm	

Notes:

- battery capacity is defined by the 20 hour rate
- the oil specification should be for the minimum ambient temperature as the oil will not be warmed by the immersion heater
- breakaway current is dependent on the battery capacity available. Cables should be capable of handling transient current twice that of cranking current

Exhaust system

Maximum back pressure - 1800 rpm	10 kPa
Exhaust outlet, internal diameter	123 mm

Induction system

Maximum air intake restriction

Clean filter	2,5 kPa
Dirty filter	6,4 kPa
Air filter type	Paper element - 15 inch diameter

Fuel system

Injection systemMEUI
 Injector typeMEUI
 Governor typeelectronic
 Governing conforms toISO8528-5 Class G2
 Injector pressure.....207 MPa

Fuel lift pump

Lift pump type gear driven
 Lift pump delivery - 1800 rpm 600 litres/hour
 Lift pump delivery pressure621 kPa
 Maximum suction head at pump inlet3 m
 Maximum static pressure head4 m
 Maximum fuel inlet temperature55 °C
 Fuel filter spacing primary 10 microns
 Fuel filter spacing secondary2 microns

Fuel specification

BS2869 Class A2 or BSEN590
 ASTM D975 Class 1D and Class 2D

Note: For further information on fuel specifications and restrictions, refer to the OMM, "Fluid Recommendations" for this engine model.

Fuel consumption

Load	2206D-E13TAG2		2206D-E13TAG	
	1800 rpm			
	g/kWh	litres/hr	g/kWh	litres/hr
Standby	206	93	204	105
110% Prime power	209	94	207	102
100% Prime power	210	87	209	94
75% Prime power	217	67	214	73
50% Prime power	229	48	225	52

Note: All fuel consumption figures are based on nett power

Lubrication system

Maximum total system oil capacity 40.0 litres
 Minimum oil capacity in sump 32,5 litres
 Maximum oil capacity in sump 38.0 litres
 Maximum engine operating angles -
 front up, front down, right side, left side 7°

Lubricating oil

Oil flow @ 1800 rpm172 litres/min
 Oil pressure at bearings (1800 rpm).....358 kPa
 Oil pressure at bearings (minimum)270 kPa
 Oil temperature (continuous operation) 113 °C
 Oil consumption at full load as a % of fuel consumption0.15%
 Oil filter screen spacing 30 microns
 Oil consumption as % of fuel consumption.....0,1
 Sump drain plug tapping1 1/8 UNF
 Lubricating oil specificationAPI-CH4 - SAE15W-40

Mountings

Maximum static bending moment at rear face of block..... 1356 Nm

Recommended SAE viscosity

A multigrade oil must be used which conforms to EMALRG-1 or API CH-4 viscosity grade must be used, see illustration below:

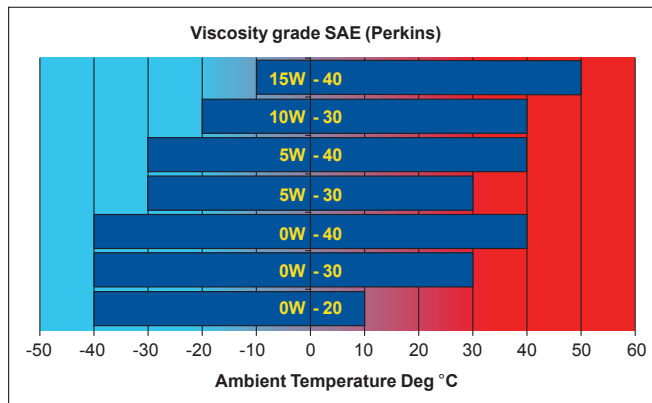

Load acceptance (TAG2 and TAG3 cold)

The information shown below complies with the requirements of classification 3 and 4 of ISO 8528-12 and G2 operating limits stated in ISO 8528-5

The below figures were obtained under the following test conditions:

Minimum engine block temperature.....45 °C
 Ambient temperature 15 °C
 Governing mode isochronous
 Alternator efficiency92%
 Alternator inertia6,9 kgm²
 Under frequency roll off (UFRO) point set to 1 Hz below rated
 UFRO rate set to 2% voltage/1% frequency
 LAM on/off off

All tests were conducted using an engine which was installed and serviced to Perkins Engines Company Limited recommendations.

Initial load application: When engine reaches rated speed (15 seconds maximum after engine starts to crank)			
Description	Units	60 Hz	
		TAG2	TAG3
% of prime power	%	65	60
Load (nett)	kWm	208	210
Transient frequency deviation	%	< 10	
Frequency recovery time	Seconds	5	

Second load application: When engine reaches rated speed (5 seconds after initial load application)			
Description	Units	60 Hz	
		TAG2	TAG3
% of Prime power	%	85	
Load (nett)	kWm	272	297
Transient frequency deviation	%	< 10	
Frequency recovery time	Seconds	5.0	

Note: The general arrangement drawings shown in this data sheet are for guidance only. For installation purposes, latest versions should be requested from the Applications Department, Perkins Engines Stafford, ST16 3UB United Kingdom.

2206D-E13TAG2 and 2206-E13TAG3 - GA Z13620 (60 Hz)

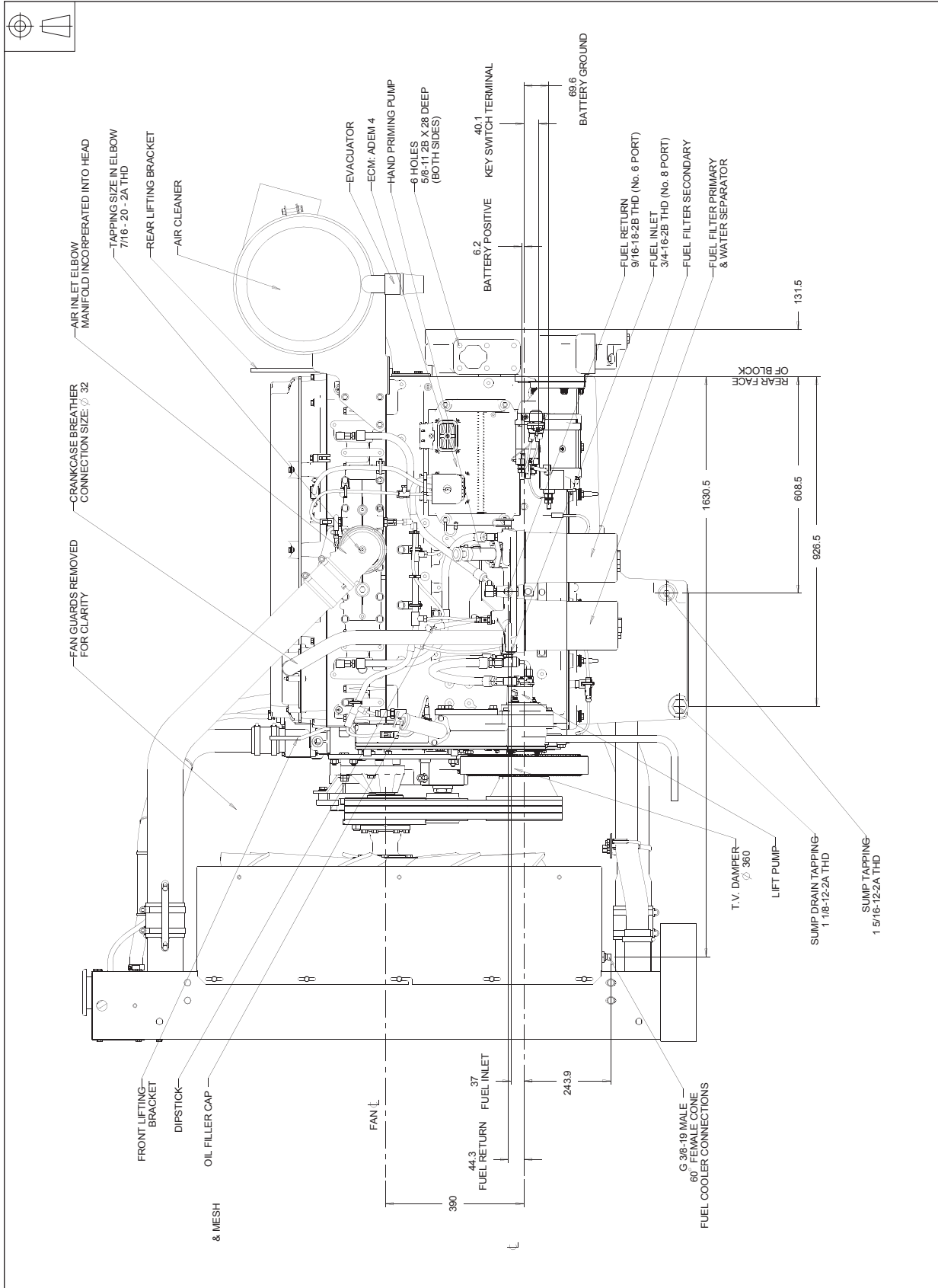

2206D-E13TAG2 and 2206-E13TAG3 - GA Z13620 (60 Hz)

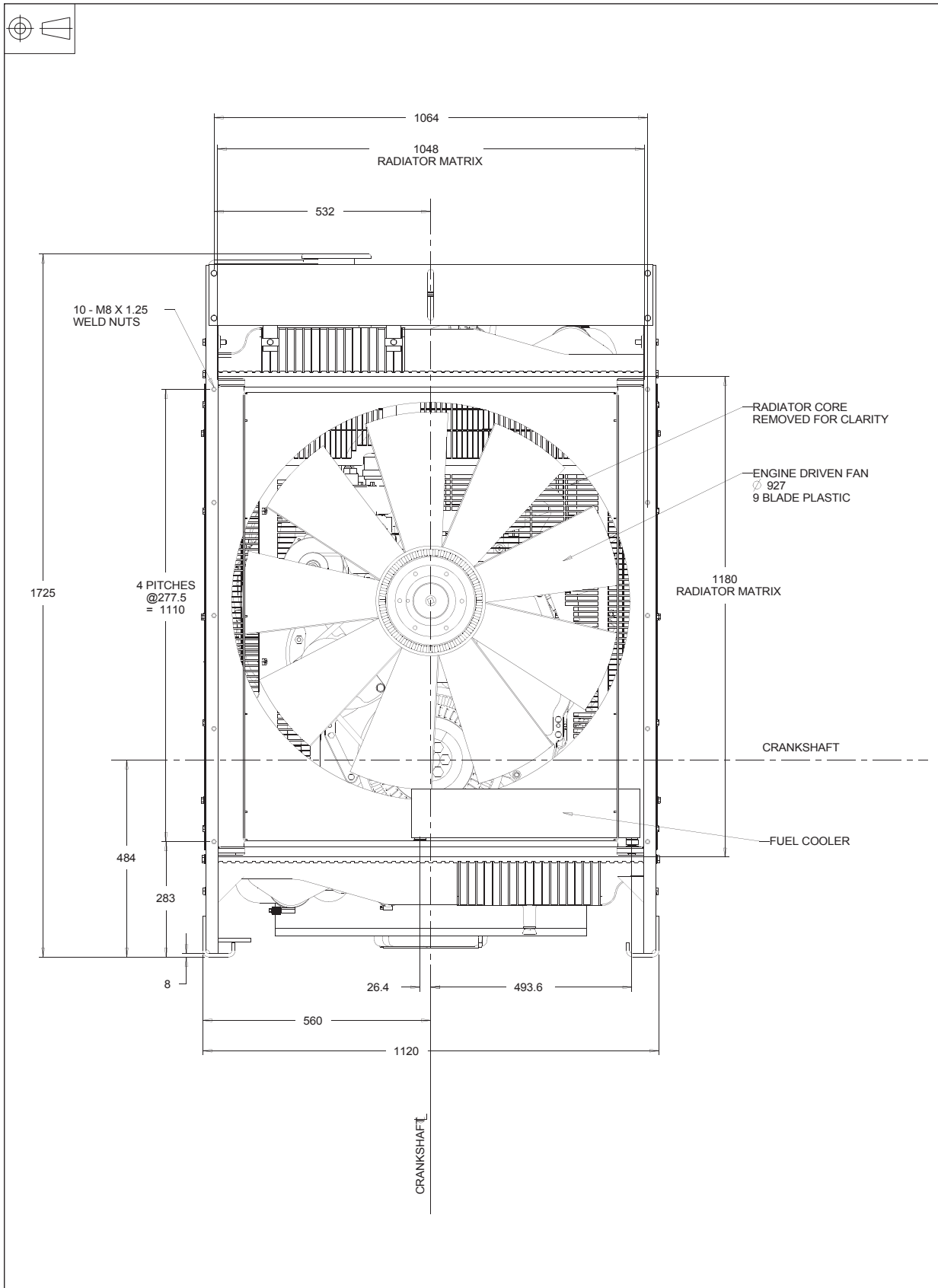

2206D-E13TAG2 and 2206-E13TAG3 - GA Z13620 (60 Hz)

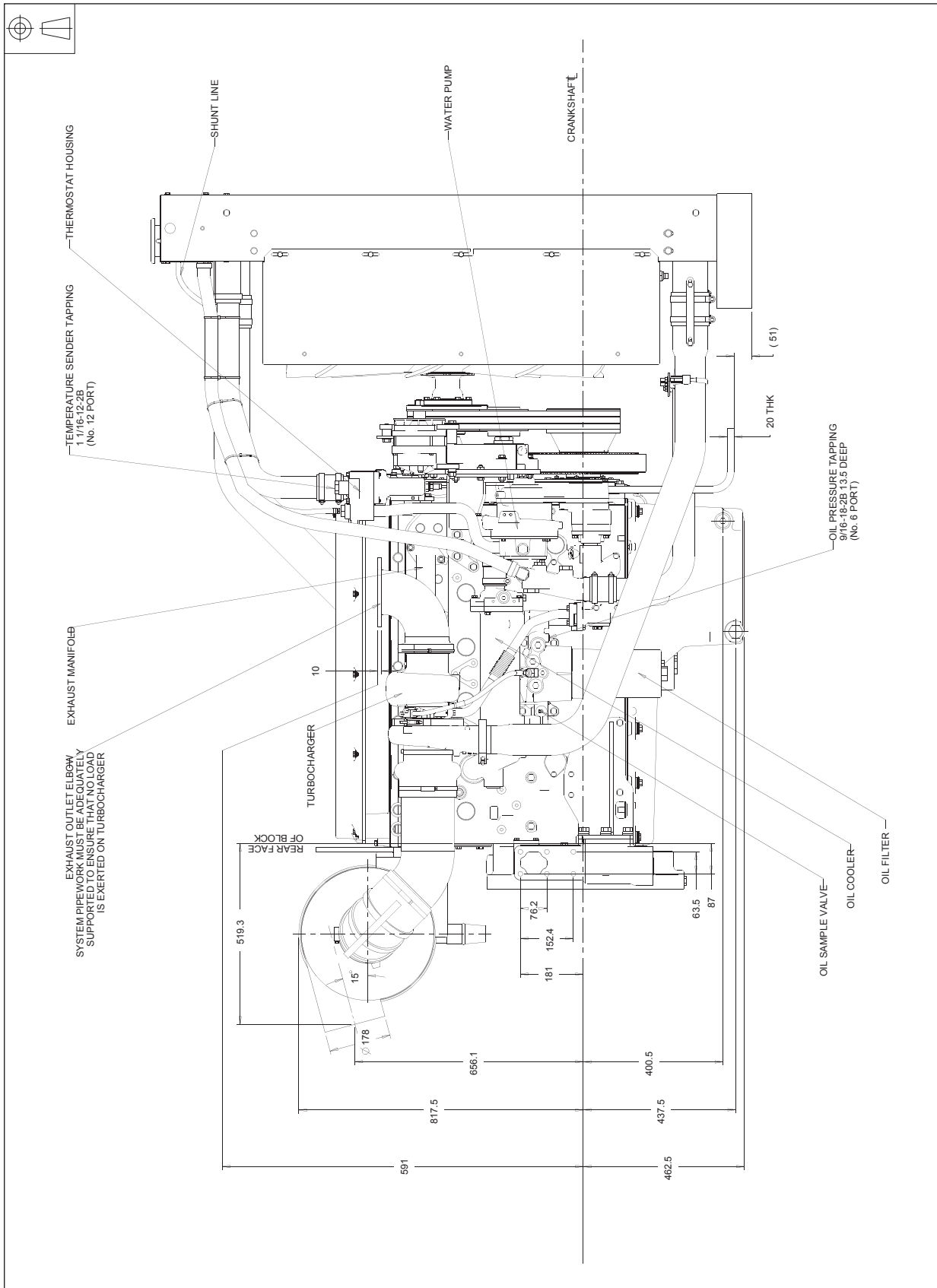

2206D-E13TAG2 and 2206-E13TAG3 - GA Z13620 (60 Hz)

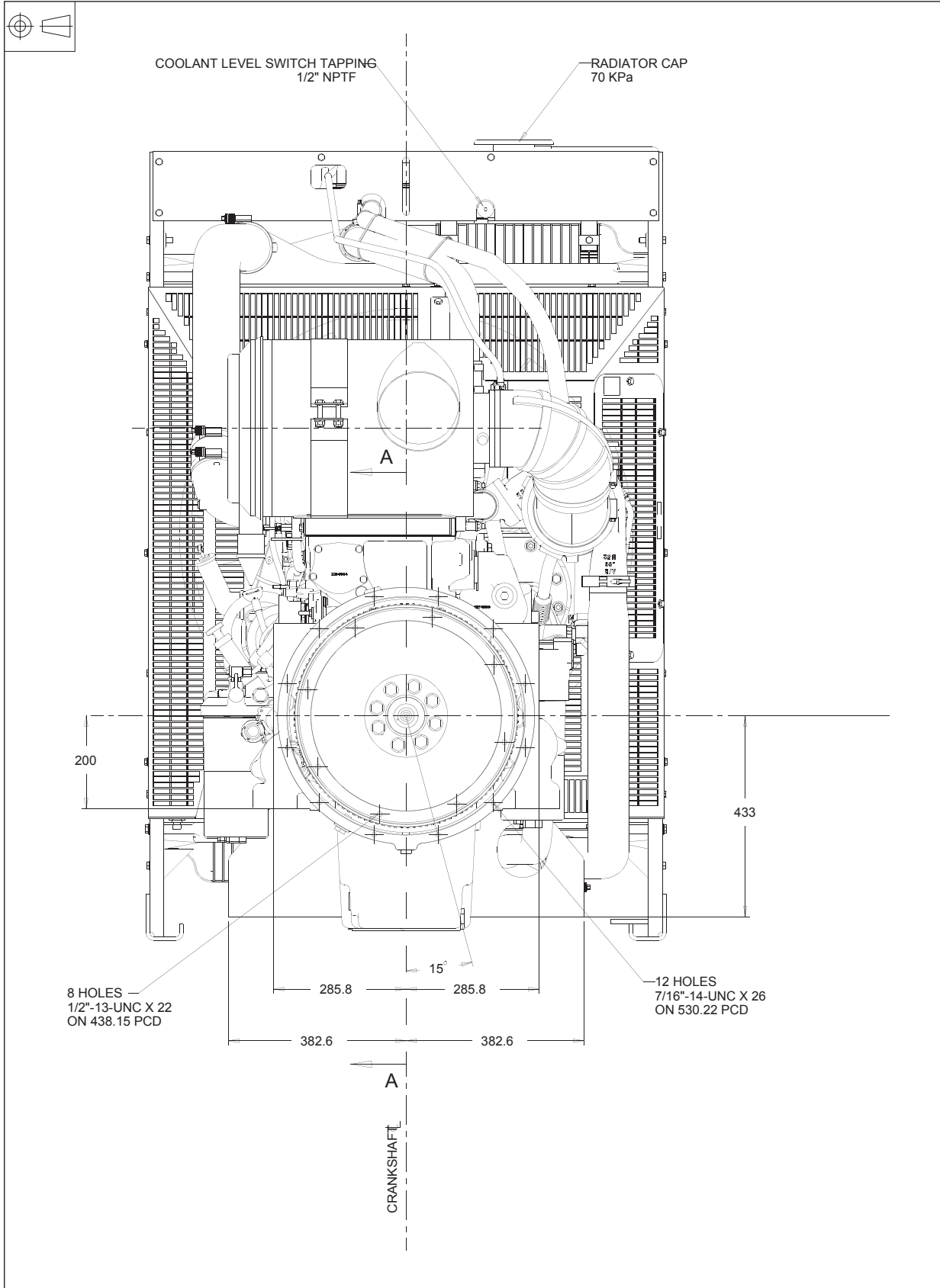

2206D-E13TAG2 and 2206-E13TAG3 - GA Z13620 (60 Hz)

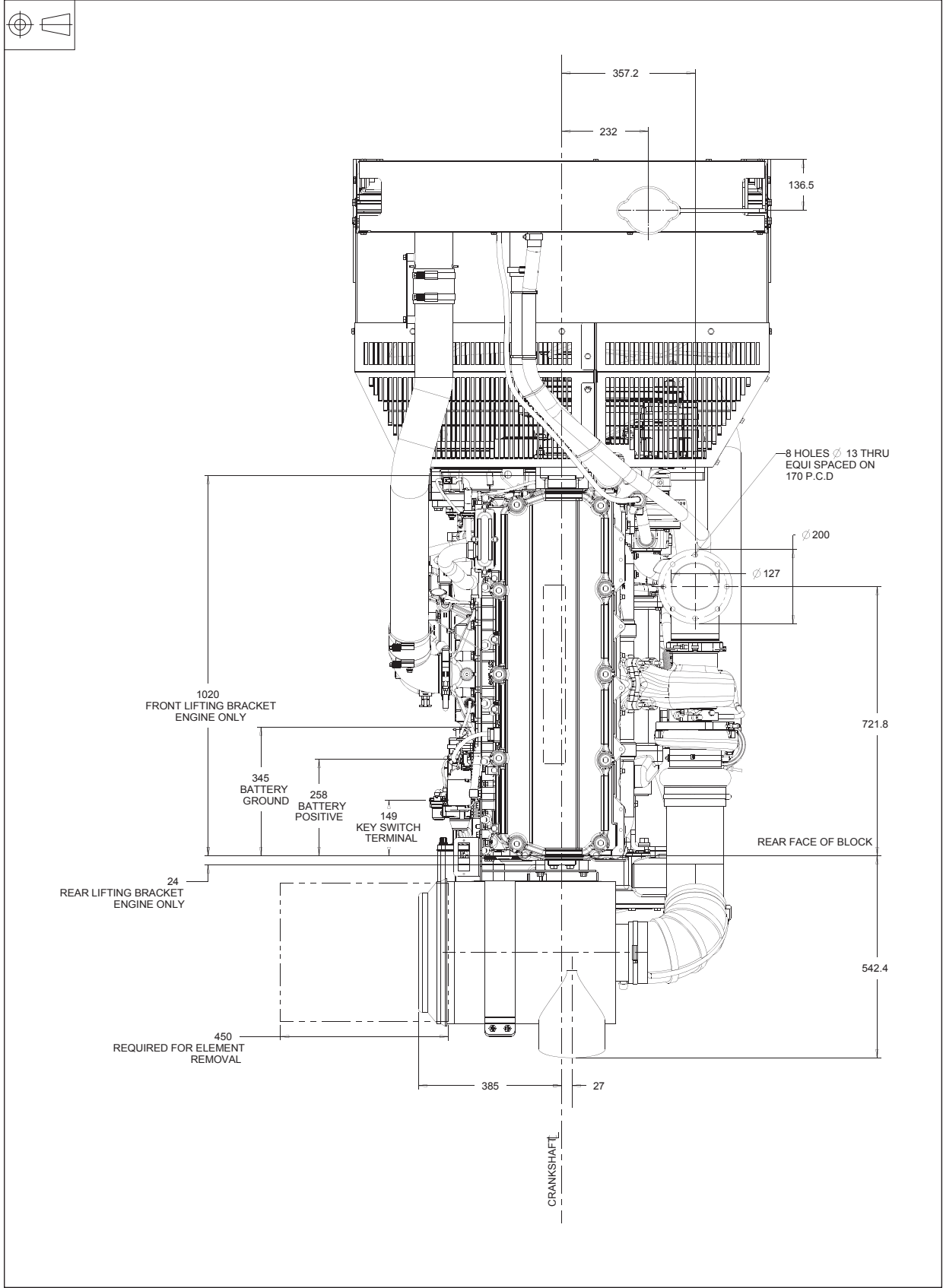

2206D-E13TAG2 and 2206-E13TAG3 - GA Z13620 (60 Hz)

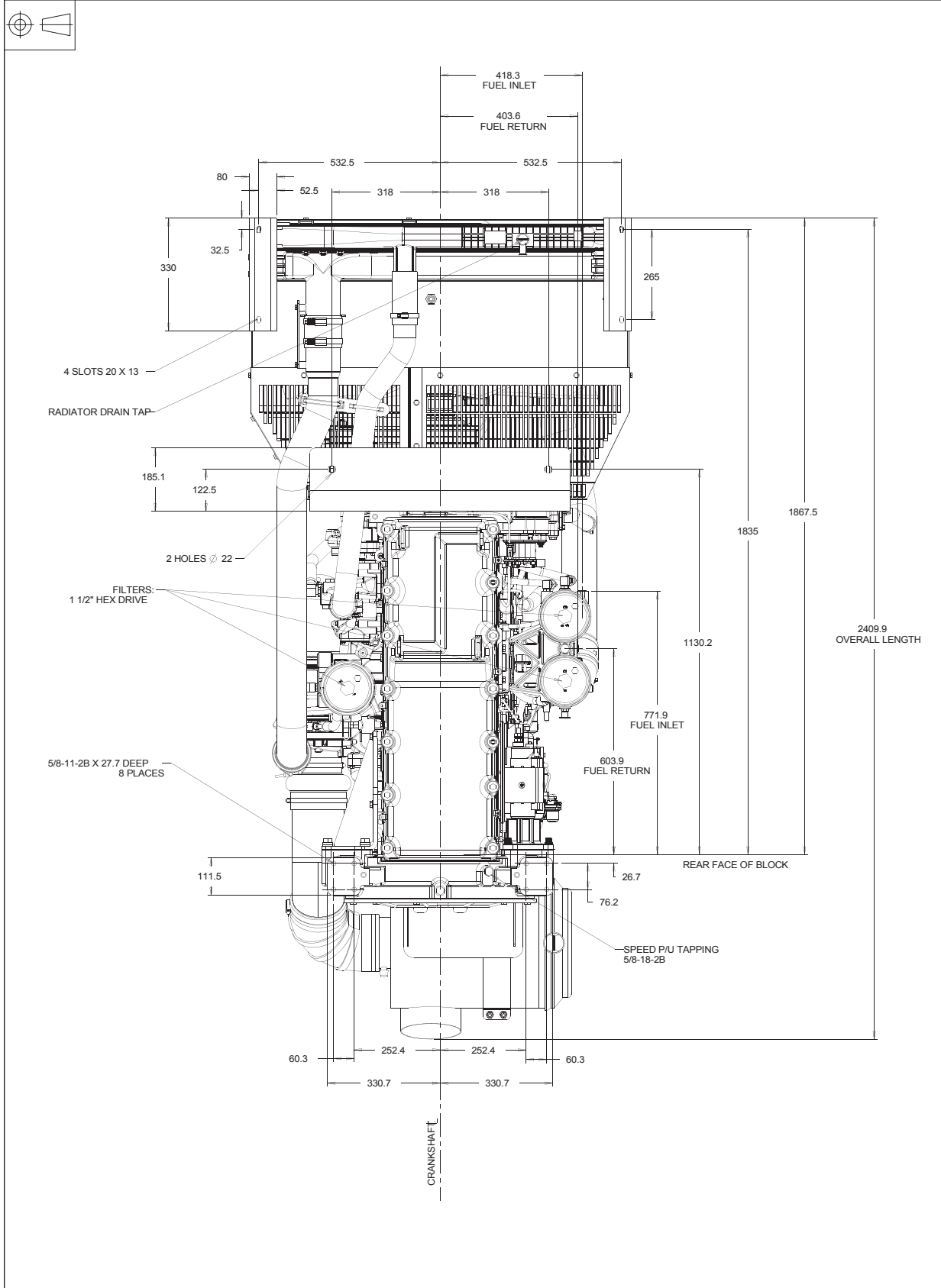

2206D-E13TAG2 and 2206-E13TAG3 - GA Z13620 (60 Hz)



SCRAP VIEW SHOWING DETAILS OF REAR LIFTING EYE

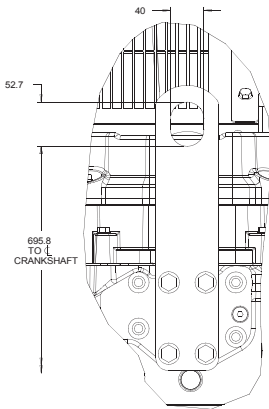

SCALE 1:2

SCRAP VIEW SHOWING DETAILS OF FRONT LIFTING EYE

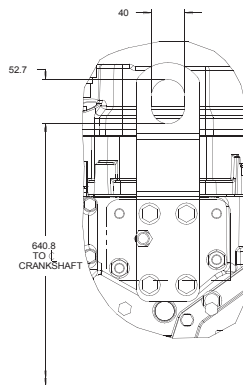

SCALE 1:2

SCRAP VIEW SHOWING DETAILS OF SHUNT PIPE CONNECTION

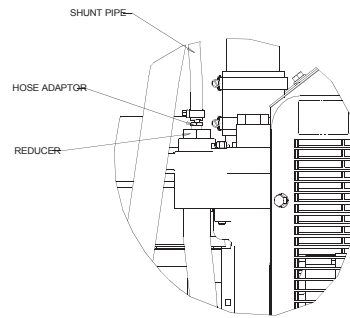

SCALE 1:2

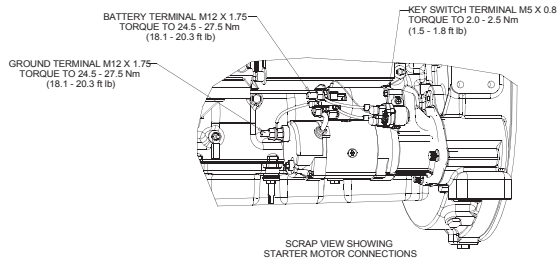

SCRAP VIEW SHOWING STARTER MOTOR CONNECTIONS

SCALE 3:10

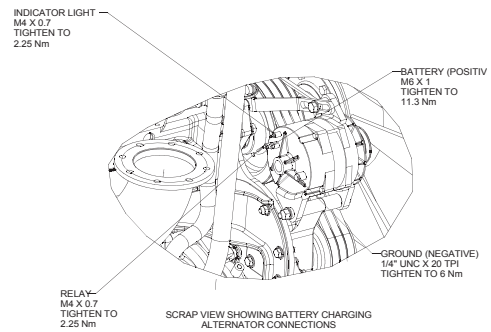

SCRAP VIEW SHOWING BATTERY CHARGING ALTERNATOR CONNECTIONS

SCALE 3:10

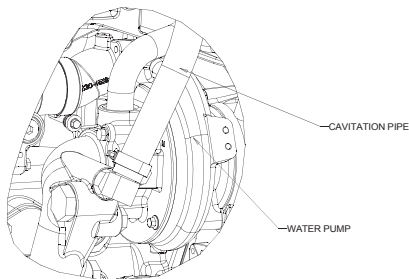

SCRAP VIEW SHOWING CAVITATION PIPE CONNECTION TO WATER PUMP

(3A000666)
(31000447)

2206D-E13TAG2 and 2206-E13TAG3 - GA Z13620 (60 Hz)

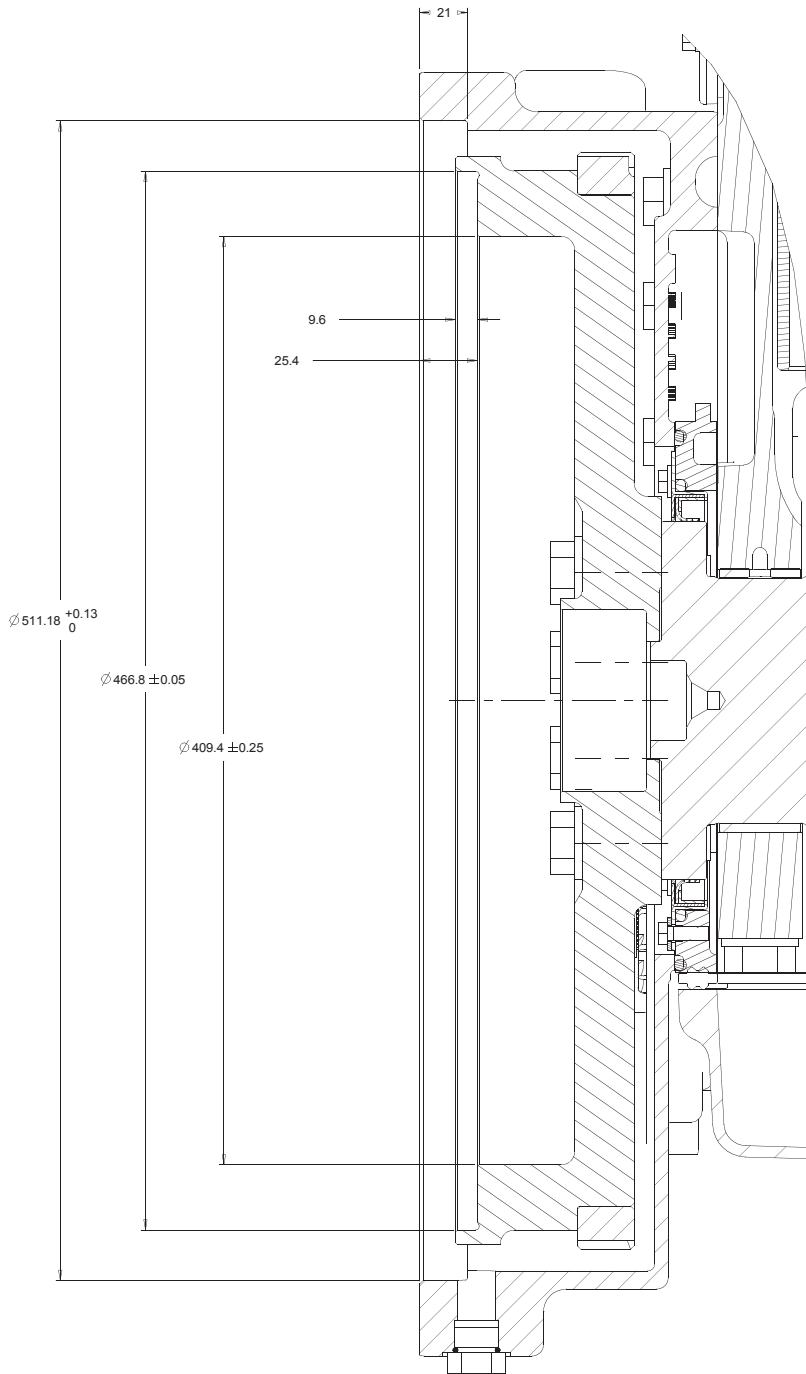

SCALE 1:1
 SECTION A-A (SHEET 1)
 CROSS SECTIONAL VIEW OF FLYWHEEL HOUSING
 DETAILS OF SAE J617 SIZE 1 FLYWHEEL HOUSING
 AND SAE J620 SIZE 14 FLYWHEEL